

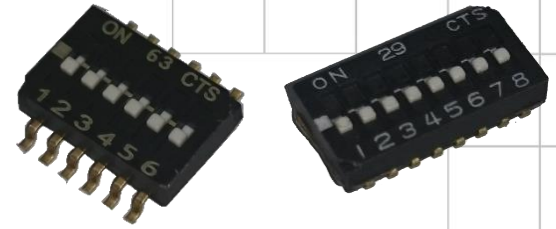

Series 218

Half Pitch, SMD DIP Switch

- Removable tape seal to withstand IR vapor phase or wave soldering temperatures, and board washing
- Gull-wing and “J” bend terminal configurations
- Low profile actuators prevent accidental actuation
- SPST configuration available
- 0.6mm/.024” actuator travel
- Optional top tape seal for board spray washing



Description

Positive detent separated from contactor causes contactor does not deflect during actuation. Unique compact type design allows to be used at mini size application. Optional sealed structure is optimized for board washing during soldering process. It makes it the ideal choice for any server, security and HVAC systems

Ordering Information

| Series | Number of Switch Positions | Low Profile Actuator | Bottom Epoxy Seal | Top Tape Seal | Terminal Type | Packaging Type | Actuation Preset |
|-------------|--------------------------------|----------------------|-------------------|----------------------|---------------|--------------------|----------------------------|
| 218- | 12 | LP | S | T | J | R | F |
| | ↓ | | | ↓ | | ↓ | |
| Code | No. of switch positions | | Code | Top tape seal | | Code | Spec. |
| 2 | 2 positions | | Blank | No top tape seal | | Blank | Anti-static tube packaging |
| 4 | 4 positions | | T | Top tape seal | | R | Tape & reel packaging |
| 6 | 6 positions | | | | | | |
| 8 | 8 positions | | | | | | |
| 10 | 10 positions | | | | | | |
| 12 | 12 positions | | | | | | |
| | | | | | ↓ | | |
| | | | | | Code | Spec. | |
| | | | | | Blank | Gull wing terminal | |
| | | | | | J | J bend terminal | |
| | | | | | | | ↓ |
| | | | | | | Code | Spec. |
| | | | | | | Blank | Ship at ON position |
| | | | | | | F | Ship at OFF position |

Notes: Contact CTS for other common features not listed.

Electrical Specifications

| Parameter | Conditions & Remarks | Min | Max | Unit |
|-----------------------|-----------------------------------|-----|-------|-----------|
| Circuit | SPST | 2 | 12 | position |
| Contact Resistance | Initial | | 100 | milliohms |
| | At end of life | | 100 | milliohms |
| Insulation Resistance | Between insulated terminals | 100 | | megohms |
| Dielectric Strength | 350 VAC between adjacent switches | | 1 | minute |
| Actuation Life | 25mA @ 24 VDC | | 1,000 | cycles |
| Switch Capacitance | Between adjacent closed switches | | 10 | pF |
| | | | 100 | mA |
| Nonswitching Rating | | | 50 | VDC |

Mechanical and Environmental

| | |
|-----------------------------|-----------------------------------------------------------------------------------------------------------------------------------------------|
| Soldering | Maximum reflow temperature, 250°C for 30 seconds |
| MSL | Level 1 |
| RoHS | Lead-Free. Fully compliant to RoHS Directive 2011/65/EU |
| Shock | Per MIL-STD-202G, method 213B, condition A(50G's) with no contact inconsistencies greater than 1 microsecond |
| Vibration | Per MIL-STD-202G, method 204D, condition B (.06" or 15G's between 10 HZ to 2K HZ) with no contact inconsistencies greater than 1 microsecond |
| Coplanarity | 0.1mm/.004" maximum |
| Seal | Bottom epoxy seal standard Top tape seal optional |
| Marking | Special marking available-consult CTS |
| Packaging: | Standard anti-static tube packaging Optional tape and reel packaging |
| Operating Temperature Range | -55°C to +85°C |
| Storage Temperature Range | -55°C to +85°C |

Soldering Profile

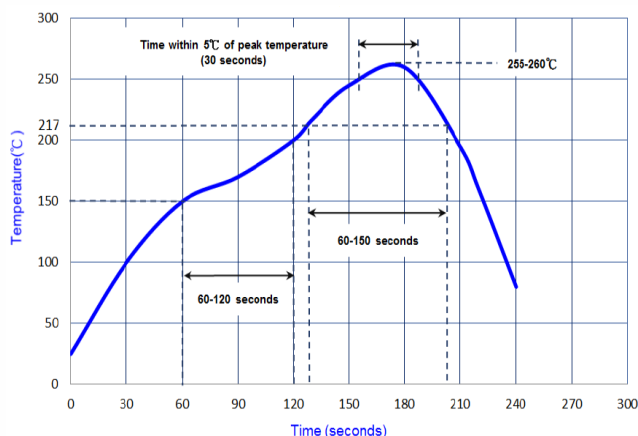

Mechanical Specifications

Figure 1 – Surface Mount J Bend Terminal

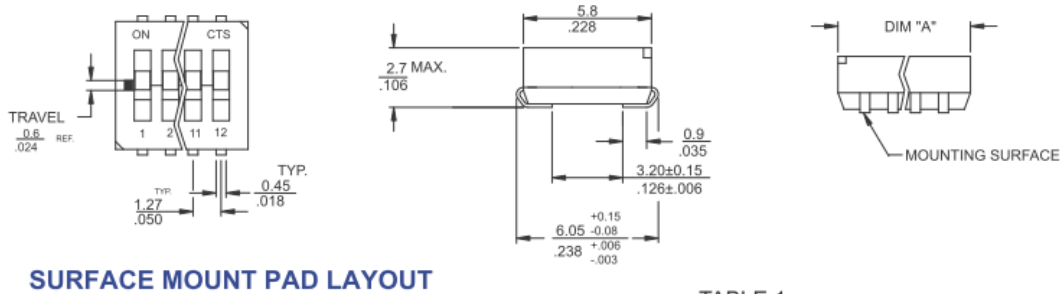

SURFACE MOUNT PAD LAYOUT

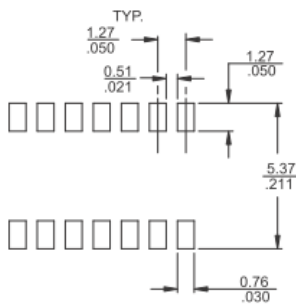
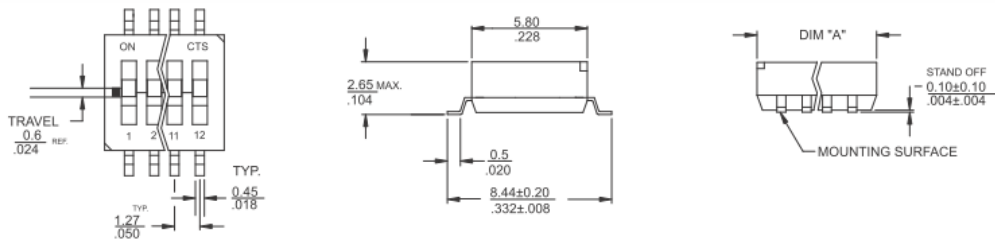

TABLE 1

| NO. OF SWITCH POSITIONS | "A" OVERALL DIMENSIONS |
|-------------------------|------------------------|
| 2 | 3.71/.146 |
| 4 | 6.25/.246 |
| 6 | 8.79/.346 |
| 8 | 11.33/.446 |
| 10 | 13.87/.546 |
| 12 | 16.41/.646 |

DIMENSION: $\frac{\text{mm}}{\text{inch}}$
STANDARD TOLERANCE :
X (1 PLACE) : ± 0.3 XX(2 PLACE) : ± 0.13
 ± 0.012 ± 0.005

Figure 2 – Surface Mount Gull Wing Terminal



SURFACE MOUNT PAD LAYOUT

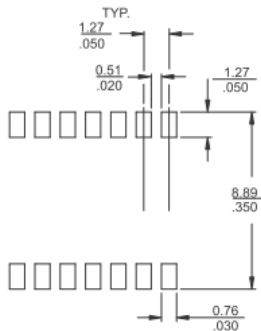

TABLE 2

| NO. OF SWITCH POSITIONS | "A" OVERALL DIMENSIONS |
|-------------------------|------------------------|
| 2 | 3.71/.146 |
| 4 | 6.25/.246 |
| 6 | 8.79/.346 |
| 8 | 11.33/.446 |
| 10 | 13.87/.546 |
| 12 | 16.41/.646 |

DIMENSION: $\frac{\text{mm}}{\text{inch}}$
STANDARD TOLERANCE :
X (1 PLACE) : ± 0.3 XX(2 PLACE) : ± 0.13
 ± 0.012 ± 0.005

Packing: Tape and Reel

Unit: mm

| SW Section | Fig | Bo | W | F |
|------------|-----|-------|------|-------|
| 2 | I | 4.51 | 16.0 | 7.50 |
| 4 | I | 7.05 | 16.0 | 7.50 |
| 6 | I | 9.75 | 16.0 | 7.50 |
| 8 | I | 12.13 | 24.0 | 11.50 |
| 10 | I | 14.67 | 24.0 | 11.50 |
| 12 | I | 17.22 | 24.0 | 11.50 |

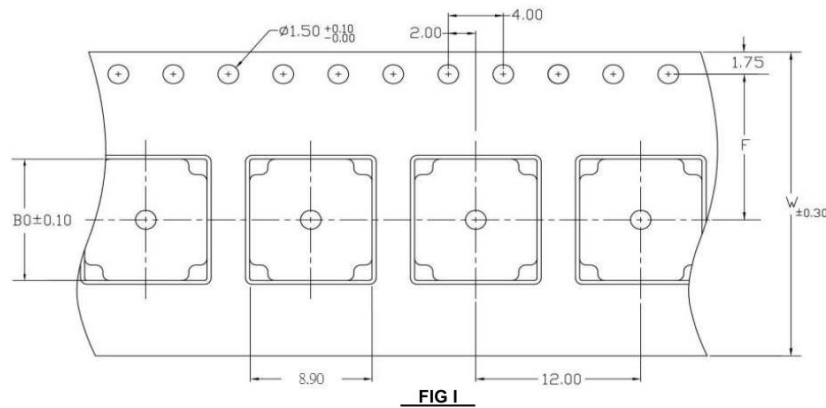

SPECIFIED REEL PARTS DIMENSIONS:

Unit: mm

| SW Section | W1 | W2 | W3 |
|------------|------|-----------|---------------------|
| 2 | 16.4 | 22.4 MAX. | 15.9 MIN./19.5 MAX. |
| 4 | 16.4 | 22.4 MAX. | 15.9 MIN./19.5 MAX. |
| 6 | 16.4 | 22.4 MAX. | 15.9 MIN./19.5 MAX. |
| 8 | 24.4 | 30.4 MAX. | 23.9 MIN./27.4 MAX. |
| 10 | 24.4 | 30.4 MAX. | 23.9 MIN./27.4 MAX. |
| 12 | 24.4 | 30.4 MAX. | 23.9 MIN./27.4 MAX. |

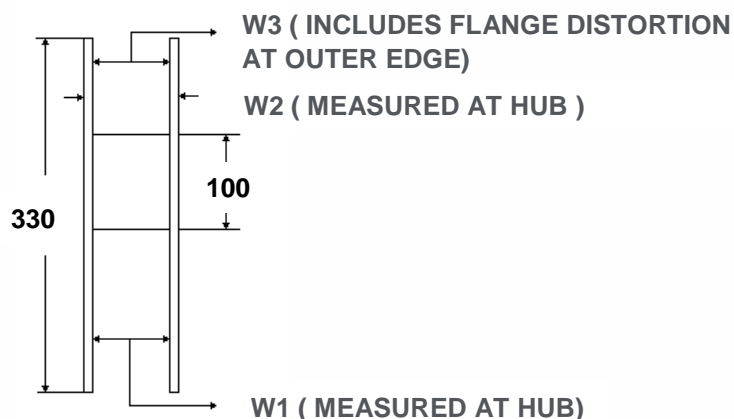

1. TAPE SPROCKET HOLE PITCH : $4.0 \pm 0.1\text{MM}$
ALL SMT ASSEMBLING MACHINES WILL PICK-UP THE COMPONENT FROM THE POINT, WHICH IS LOCATED IN THE CENTRE OF TWO ADJACENT SPROCKET HOLES IN FEEDING DIRECTION. THIS MUST BE TAKEK INTO ACCOUNT WHEN DESIGNING THE LOCATION OF THE COMPONENT IN T&R POCKET.
2. RECOMMENDED PART ORIENTATION IN TAPE & REEL POCKET.
ORIENT SWITCH TERMINAL #1 TO THE SIDE OF ROUND SPROCKET HOLES, SEE PICTURE BELOW.

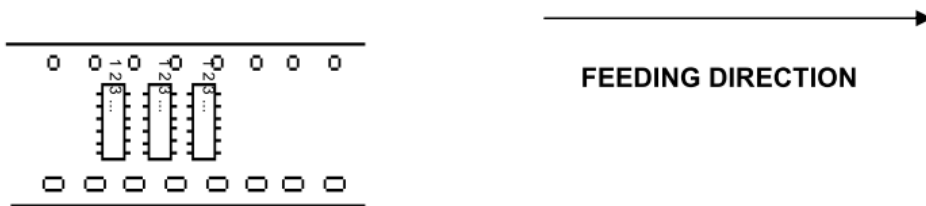

- 3 LENGTH OF TAPE
THERE SHALL BE A LEADER OF 400mm MINIMUM WHICH IS SEALED ONTO EMPTY CARRIER TAPE, SEE PICTURE BELOW.



4. TAPE BREAK FORCE, PEEL STRENGTH AND ANGLE.
REQUIRED SETTINGS :
- TOP COVER TAPE PEEL FORCE : 10 ~ 130 gm
 - ANGLE BETWEEN THE TOP COVER TAPE AND THE DIRECTION OF FEED DURING PEEL OFF : 165°~ 180°

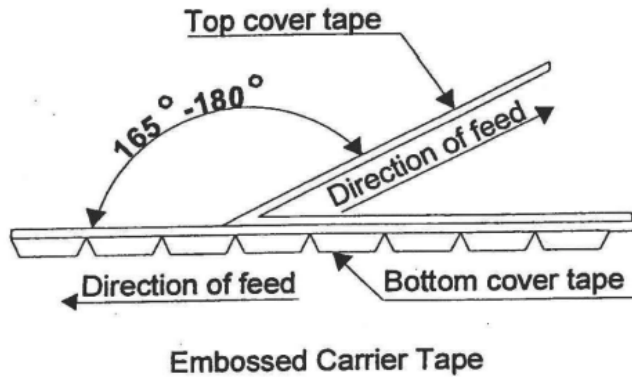

THE COVER TAPES MAY NOT EXTEND OVER THE EDGE OF THE CARRIER TAPE OR COVER ANY PART OF THE SPROCKETS HOLES.

Mouser Electronics

Authorized Distributor

Click to View Pricing, Inventory, Delivery & Lifecycle Information:

CTS:

[218-12LPST](#) [218-4LPSTR](#) [218-6LPSTR](#) [218-6LPSTJ](#) [218-8LPSTR](#) [218-8LPSTJ](#) [218-10LPSTR](#) [218-10LPSTJ](#)
[218-12LPSTR](#) [218-12LPSTJ](#) [218-10LPST](#) [218-2LPST](#) [218-2LPSTJ](#) [218-2LPSTR](#) [218-4LPST](#) [218-6LPST](#) [218-](#)
[8LPST](#) [218-4LPSJF](#) [218-6LPSTJRF](#) [218-4LPSTJR](#) [218-4LPSTJ](#) [218-2LPSTF](#) [218-4LPSTRF](#) [218-6LPS](#) [218-](#)
[4LPSJRF](#) [218-4LPS](#) [218-8LPS](#) [218-2LPS](#) [218-4LPSJ](#) [218-4LPSTF](#) [218-6LPSTRF](#) [218-2LPSTRF](#) [218-8LPSTRF](#)
[218-06LPSTJF](#) [218-2LPSTJRF](#) [218-8LPSTJRF](#) [218-10LPSRF](#) [218-10LPSTF](#) [218-8LPSTF](#) [218-12LPSTJRF](#) [218-](#)
[2LPSR](#) [218-6LPSF](#) [218-8LPSRF](#) [218-12LPSJRF](#) [218-4LPSR](#) [218-4LPSRF](#) [218-12LPSJR](#) [218-12LPSTRF](#) [218-](#)
[2LPSTJR](#) [218-6LPSJ](#) [218-8LPSF](#) [218-8LPSTJR](#) [218-10LPS](#) [218-10LPSTJF](#) [218-2LPSTJF](#) [218-6LPSJF](#) [218-](#)
[10LPSJRF](#) [218-12LPSF](#) [218-8LPSJR](#) [218-10LPSTJRF](#) [218-12LPSR](#) [218-12LPSRF](#) [218-2LPSF](#) [218-2LPSJ](#) [218-](#)
[8LPSJ](#) [218-12LPSJ](#) [218-12LPSTJR](#) [218-2LPSJRF](#) [218-4LPSJR](#) [218-8LPSR](#) [218-10LPSTRF](#) [218-6LPSJR](#) [218-](#)
[6LPSJRF](#) [218-10LPSF](#) [218-8LPSJF](#) [218-10LPSR](#) [218-12LPSJF](#) [218-2LPSRF](#) [218-6LPSTJF](#) [218-4LPSF](#) [218-](#)
[4LPSTJF](#) [218-6LPSR](#) [218-6LPSRF](#) [218-6LPSTF](#) [218-10LPSJF](#) [218-10LPSJR](#) [218-12LPS](#) [218-12LPSTF](#) [218-](#)
[12LPSTJF](#) [218-4LPSTJRF](#) [218-8LPSJRF](#) [218-8LPSTJF](#) [218-2LPSJF](#) [218-2LPSJR](#) [218-10LPSTJR](#) [218-10LPSJ](#)
[218-6LPSTJR](#) [218-8LPSTROFF](#)